











Steam Application Map

LEGEND:

-  Regulator
-  Safety Relief Valve
-  Isolation Valve
-  Control Valve
-  ARC Valve
-  Continuous Blowdown Valve
-  Blow-off Valve
-  Globe Valve
-  Steam
-  Condensate
-  Steam / Condensate

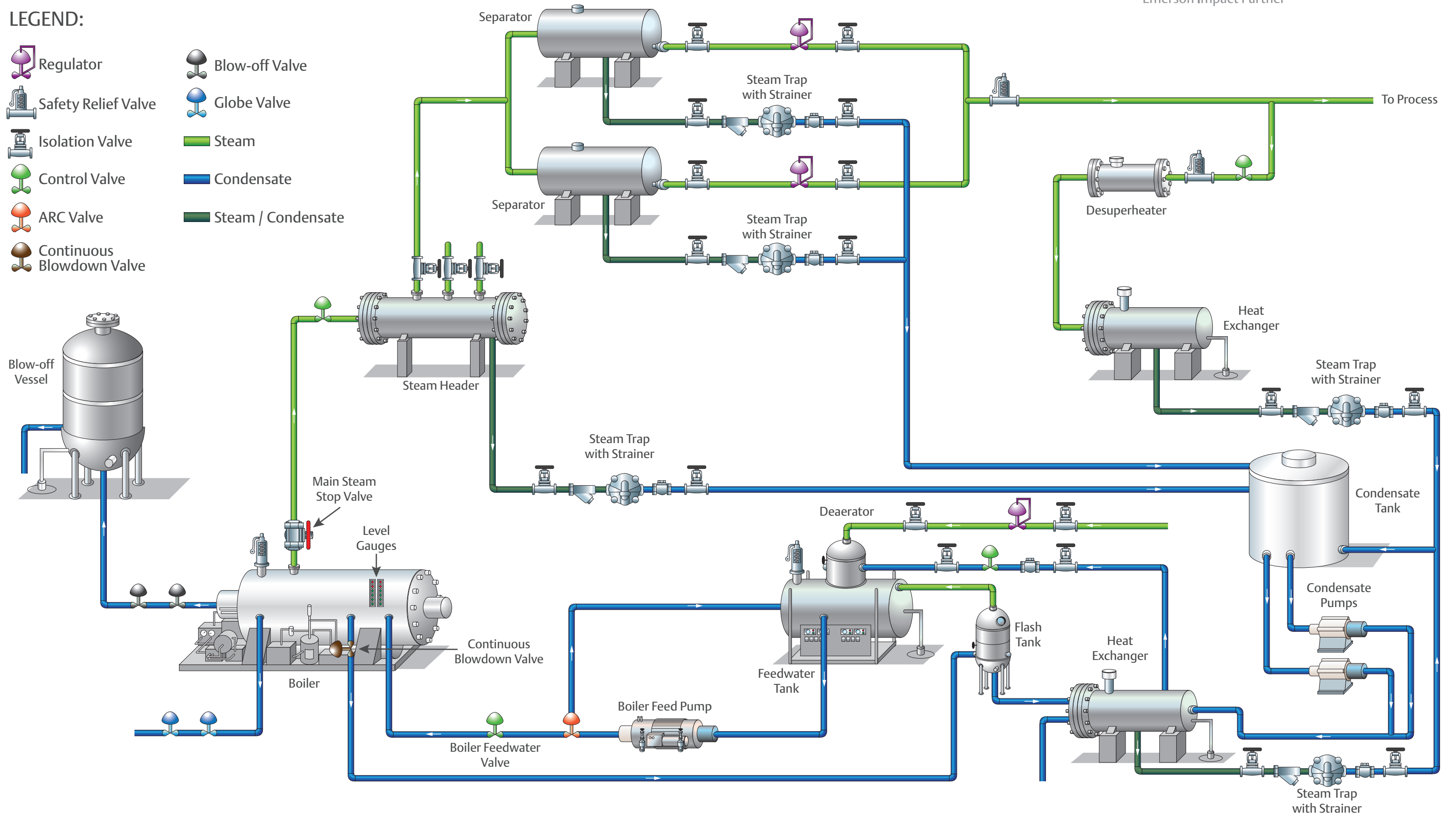

Applied Control Equipment, LLLP.

Emerson Impact Partner: Colorado | Wyoming | Montana | Nebraska | South Dakota

Headquarters: 13705 Compark Blvd, Englewood, CO 80112

Contact: 303-799-9300 | info@appliedcontrol.com | appliedcontrol.com